



CENTURION

SMARTGUARD
pocket installation guide



SMART GUARD™

**HIGH SECURITY
KEYLESS ACCESS
CONTROL**

1. KwikLearn >>

The following KwikLearn procedure will enable you to start using your **SMARTGUARD** system right away. Additional procedures are explained later in this guide.

Add a new access code at a specified address.

The code will operate Channel 1 only.

	Indicator LEDs
Enter the following keystrokes:	
1. Enter Program Mode * Master Code ¹ *	
2. Select KwikLearn 0 #	
3. Enter user address 0 #	
4. Enter access code Code #	

¹ Default Master Code=1234

Example:

Kwiklearn access code 9 3 2 4 5 into address 2 5
Master Code= 1 2 3 4

	Indicator LEDs
Enter the following keystrokes:	
1. Enter Program Mode * 1 2 3 4 *	
2. Select KwikLearn 0 #	
3. Enter user address 2 5 #	
4. Enter access code 9 3 2 4 5 #	

2. How to use this Guide >>

The procedures in this Guide require the user to perform certain sequential actions on the **SMARTGUARD** keypad. To assist you, the combined state of the three LED indicators on the keypad correspond with particular steps within a procedure. When carrying out the procedures, please be aware of the following:

The factory default Master Code 1 2 3 4 is used throughout this Guide as an example only. Refer to Section 6 for instructions on how to change the Master Code.

- Indicates a particular key to be pressed on the keypad by the user
- Indicates a lit LED
- [] Indicates optional entries.

Important when choosing an access code number

If you intend using the Duress Security Parameter ensure that no consecutive numbers are assigned as codes.

Ensure that the desired code has not already been allocated

3. Icons used in this guide >>



This icon indicates tips and other information that could be useful during the installation.



This icon denotes variations and other aspects that should be considered during installation.



This icon indicates a warning, caution or attention! Please take special note of critical aspects that MUST be adhered to in order to prevent injury.

4. General description >>

The CENTURION **SMARTGUARD** is a durable, quality keypad designed to provide high-security access control to restricted areas. The unit is weatherproof, and the keys are backlit for ease of use at night. Access is granted by the keying in of a valid access code. The access code can vary from one to ten digits. Up to one thousand different access codes can be stored within the unit's non-volatile memory. New codes can be added, and existing codes deleted as required. "Token" codes can be added, allowing only a preset number of activations, after which the code becomes invalid. Each code can operate one or more of the three available outputs. The first output is a potential-free relay contact capable of switching up to 3A at 50V. Both normally-closed and normally-open contacts are available. The second and third outputs are open collector channels, capable of directly switching any negative triggered equipment, or an external relay. The output channels can be set as pulsed or latching, with pulse times adjustable in one second increments between one second and four minutes. The open collector output channels can be used with the optional CP105 SmartSwitch, allowing secure control of equipment a distance away from the main unit. An anti-hack feature can be enabled, causing the unit to shut down after a pre-selected number of incorrect codes have been entered. The unit will then reset after a pre-selected time. A telltale LED will indicate that the anti-hack feature has been triggered. The third output channel can be used as an alarm channel, triggered by various panic or alarm conditions. The relay output can be activated by an external pushbutton, giving free-exit capability. Once programmed, the system can be backed up onto the optional CP108 backup module. This allows the system to be easily restored if required. An optional independent tamper switch can be fitted to provide a contact indicating if the unit has been forced open, or removed from its mountings.

5. Technical specifications >>>

Supply voltage	12V - 24V AC/DC
Standby current	32mA
Maximum current	180mA1
Operating temperature	-15C to +55C
Operating humidity	0-90%2
Output relay rating	1 x 3A @ 50V3
Open collector rating	2 x 50mA @ 24V
Housing material	Polycarbonate
Degree of protection	IP55
Code length	one to ten digits
Memory capacity	1000 unique non-volatile codes
Memory retention	>200 years
Output pulse range	1 - 255s adjustable, or latched
Token codes	1 - 254 activations

1. All outputs active, SmartSwitches on Ch2 & Ch3
2. Non-condensing
3. Non-inductive load

6. Changing the Master Code >>>

The following procedure will enable the user to change the default Master Code **1 2 3 4** or the currently stored Master Code to a new Master Code. The Master Code may also be learned into the system by following the procedure in Section 8 'Adding a New User'.



The Master Code must always be stored at address **0**
The Master Code can be used as a normal access code

		Indicator LEDs
Enter the following keystrokes:		<input type="radio"/> <input type="radio"/> <input checked="" type="radio"/>
1. Enter Program Mode	* Master Code¹ *	<input checked="" type="radio"/> <input type="radio"/> <input type="radio"/>
2. Select KwikLearn	0 #	<input checked="" type="radio"/> <input checked="" type="radio"/> <input type="radio"/>
3. Enter address	0 #	<input checked="" type="radio"/> <input checked="" type="radio"/> <input checked="" type="radio"/>
4. Enter new code	Code #	<input type="radio"/> <input type="radio"/> <input checked="" type="radio"/>
¹ Default Master Code=	1 2 3 4	

Example: Replace the default Master Code **1 2 3 4** with a new Master Code = **3 7 8 1**

		Indicator LEDs
Enter the following keystrokes:		<input type="radio"/> <input type="radio"/> <input checked="" type="radio"/>
1. Enter Program Mode	* 1 2 3 4 *	<input checked="" type="radio"/> <input type="radio"/> <input type="radio"/>
2. Select KwikLearn	0 #	<input checked="" type="radio"/> <input checked="" type="radio"/> <input type="radio"/>
3. Enter address	0 #	<input checked="" type="radio"/> <input checked="" type="radio"/> <input checked="" type="radio"/>
4. Enter access code	3 7 8 1 #	<input type="radio"/> <input type="radio"/> <input checked="" type="radio"/>

7. Adding a new user >>>

The following procedure will add a new access code at a specified address, assign which channel the code must activate and how many accesses are allowed before the code becomes invalid.

		Indicator LEDs
Enter the following keystrokes:		<input type="radio"/> <input type="radio"/> <input checked="" type="radio"/>
1. Enter Program Mode	* Master Code *	<input checked="" type="radio"/> <input type="radio"/> <input type="radio"/>
2. Select Add Menu	1 #	<input checked="" type="radio"/> <input checked="" type="radio"/> <input type="radio"/>
3. Enter user address	Address #	<input checked="" type="radio"/> <input checked="" type="radio"/> <input checked="" type="radio"/>
4. Enter access code	Code #	<input type="radio"/> <input checked="" type="radio"/> <input checked="" type="radio"/>
5. Select channel	Channel #	<input type="radio"/> <input type="radio"/> <input checked="" type="radio"/>
6. Assign channel	Channel #	<input type="radio"/> <input type="radio"/> <input checked="" type="radio"/>
6. Enter access limit	[Accesses] #	<input checked="" type="radio"/> <input checked="" type="radio"/> <input type="radio"/>
7. Exit Add Menu	#	<input checked="" type="radio"/> <input type="radio"/> <input type="radio"/>
8. Exit Program Mode	#	<input type="radio"/> <input type="radio"/> <input checked="" type="radio"/>



- Repeat steps 3 - 6 for additional users
- [] denotes optional features



- If no channel is specified, Channel 1 is selected
- If the number of accesses is not specified in Step 6, unlimited access is set. Care must be taken to ensure the desired access limit is correctly applied
- **If unlimited accesses are required, only enter # at Step 6.**

Example:

Add **access code 5 2 7** into **address 1 0**

The code must operate **Channel 2**

Code is valid forever

Master Code = **1 2 3 4**

Indicator LEDs

Enter the following keystrokes:

1. Enter Program Mode * 1 2 3 4 *
2. Select Add Menu 1 #
3. Enter user address 1 0 #
4. Enter access code 5 2 7 #
5. Select channel 2 #
6. Assign channel #
7. Enter access limit #
8. Exit Add Menu #
9. Exit Program Mode #

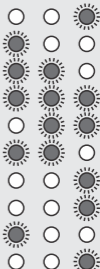
**Example:**Add **access code 9 3 5 2 3** into **address 1 0**The code must operate **Channel 5**Code is valid for **2 uses**Master Code= **1 2 3 4**

Indicator LEDs

Enter the following keystrokes:

1. Enter Program Mode * 1 2 3 4 *
2. Select Add Menu 1 #
3. Enter user address 1 0 #
4. Enter access code 9 3 5 2 3 #
5. Select channel 5 #
6. Assign channel #
7. Enter access limit 2 #
8. Exit Add Menu #
9. Exit Program Mode #

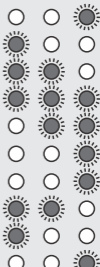
**8. Deleting a user** >>>

The following procedure will delete an access code at a specified address.

Indicator LEDs

Enter the following keystrokes:

1. Enter Program Mode * Master Code *
2. Select Delete Menu 2 #
3. Enter user address Address #
4. Exit Delete Menu #
5. Exit Program Mode #

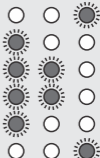

- Repeat Step 3 to delete additional user codes
- If address is specified as 0, all access codes will be deleted and the Master Code will revert to the factory default,

1 2 3 4**Example:**Delete **access code** at **address 9 9**Master Code= **1 2 3 4**

Indicator LEDs

Enter the following keystrokes:

1. Enter Program Mode * 1 2 3 4 *
2. Select Delete Menu 2 #
3. Enter user address 9 9 #
4. Exit Delete Menu #
5. Exit Program Mode #

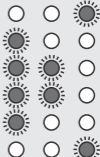
**Example:**Delete all **access codes**. Master Code= **1 2 3 4**

Indicator LEDs

Enter the following keystrokes:

1. Enter Program Mode * 1 2 3 4 *
2. Select Delete Menu 2 #
3. Enter user address 0 #
4. Exit Delete Menu #
5. Exit Program Mode #

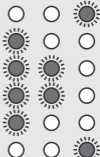
**Example:**Delete **access code** at **addresses 5 4 and 8 7**Master Code= **1 2 3 4**

Indicator LEDs

Enter the following keystrokes:



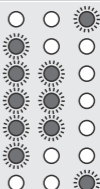

















1. Enter Program Mode * 1 2 3 4 *
2. Select Delete Menu 2 #
3. Enter user address 5 4 #
4. Enter user address 8 7 #
5. Exit Delete Menu #
6. Exit Program Mode #



9. Setting the output timers



Sets the output pulse time of the output channels. Default setting is one second pulse.

		Indicator LEDs
Enter the following keystrokes:		  
1. Enter Program Mode	* Master Code *	  
2. Select Output Menu	3 #	  
3. Enter channel	Channel #	  
4. Enter pulse time	Seconds #	  
5. Exit Output Menu	#	  
6. Exit Program Mode	#	  

Once transmission has ended, repeat Steps 3 and 4 for additional channels.























- A pulse time of zero seconds will give latched output
- Maximum pulse time is 255 seconds

Example:

Pair **Channel 1** with a **NOVA receiver**, allowing for a transmission duration of ten seconds.



















Master Code= **1 2 3 4**

		Indicator LEDs
Enter the following keystrokes:		  
1. Enter Program Mode	* 1 2 3 4 *	  
2. Select Output Menu	3 #	  
3. Enter Output channel	1 #	  
4. Enter pulse time	1 #	  
5. Exit Output Menu	#	  
6. Exit Program Mode	#	  

10. Setting the anti-hack parameters



The following procedure sets the number of wrong access codes that the **SMARTGUARD** will accept before becoming inactive, as well as the time for which it will remain inactive. The factory default for wrong access codes is three, while the default reset time is 60 seconds.

		Indicator LEDs
Enter the following keystrokes:		  
1. Enter Program Mode	* Master Code *	  
2. Select Lockout Menu	4 #	  
3. Enter number of codes	Wrong codes #	  
4. Enter Reset Time	Seconds #	  
5. Exit Program Mode	#	  





















- If the Number of wrong codes is set to zero, the unit will accept an unlimited number of wrong codes.
- If the Reset time is set to zero, the unit can only be reset by removing the power.

Example:

Set **wrong code alarm** to activate after five incorrect codes have been entered. The unit must reactivate after 30 seconds.

Master Code= **1 2 3 4**

		Indicator LEDs
Enter the following keystrokes:		  
1. Enter Program Mode	* 1 2 3 4 *	  
2. Select Lockout Menu	4 #	  
3. Enter number of codes	5 #	  
4. Enter Reset Time	3 0 #	  
5. Exit Program Mode	#	  

11. Setting the key wipeout time

The following procedure sets the number of seconds for which keystrokes remain valid. This ensures that if a partial code has been entered, it is wiped out of the keypad buffer after a preset time, and must be re-entered in its entirety.

The clearing of the keypad buffer is indicated by the keypad's back light turning off.

The factory default for the key wipeout timer is five seconds.

	Indicator LEDs
Enter the following keystrokes:	
1. Enter Program Mode * Master Code *	
2. Select Wipeout Menu 5 #	
3. Enter Wipeout Time [Seconds] #	
4. Exit Program Mode #	



- If the Wipeout time is set to **0**, key wipeout will be disabled (only applicable to externally powered devices)



Disabling the key wipeout time will:

- Compromise the security of the system
- Cause a code entry to be incorrectly recognised as a wrong code if an incomplete code was previously entered

Example:

Set the key wipeout time to 15 seconds.

Master Code=**1 2 3 4**

	Indicator LEDs
Enter the following keystrokes:	
1. Enter Program Mode * 1 2 3 4 *	
2. Select Wipeout Menu 5 #	
3. Enter Wipeout Time 1 5 #	
4. Exit Program Mode #	

Example:

Disable key wipeout time.

Master Code=**1 2 3 4**

	Indicator LEDs
Enter the following keystrokes:	
1. Enter Program Mode * 1 2 3 4 *	
2. Select Wipeout Menu 5 #	
3. Enter Wipeout Time 0 #	
4. Exit Program Mode #	

12. Setting the security parameters

The following procedure sets the conditions under which the Alarm channel (Channel 3) will activate. This also sets the anti-default and tone mute features.

The following alarm conditions can be set:

Duress (Code + 1)(Default=off)

Adding **1** to the last digit of an access code activates the unit as normal, but also activates the alarm channel. This is used if entering under duress. E.g. If the access code is **1 2 3 4**, entering **1 2 3 5** gives access, but also activates the alarm

Alarm (* + #)(Default=off)

Pressing the ***** and **#** keys simultaneously activates the Alarm channel.

Wrong Codes (Default=off)

When the number of wrong codes is exceeded, the Alarm channel is activated.

Anti-default feature (Default=on)

Setting this feature prevents the Master Code and system parameters from being reset by the defaulting features.

Alarm Tone Mute Feature (Default=off)

Setting this feature turns off the audible feedback when entering a code. This prevents an eavesdropper from determining the number of digits in the code. Tones will still be present in Programming Mode.

	Indicator LEDs
Enter the following keystrokes:	
1. Enter Program Mode * Master Code *	
2. Select Security Menu 6 #	
3. Set (Code+1) 0 OR 1 #	
4. Set (*+#) 0 OR 1 #	
5. Set (Wrong Codes) 0 OR 1 #	
6. Set Anti-default 0 OR 1 #	
7. Set Tone Mute 0 OR 1 #	
8. Exit Program Mode #	



- **0 #** turns function off, **1 #** turns function on

Example:

Enable Alarm on Code + **1**. Clear all other functions

Master Code=**1 2 3 4**

		Indicator LEDs		
Enter the following keystrokes:		○	○	☀
1. Enter Program Mode	* 1 2 3 4 *	☀	○	○
2. Select Security Menu	6 #	☀	☀	○
3. Set (Code+1)	1 #	☀	☀	☀
4. Clear (*+#)	0 #	○	☀	☀
5. Clear (Wrong Codes)	0 #	○	○	☀
6. Clear Anti-default	0 #	○	○	○
7. Clear Tone Mute	0 #	☀	○	○
8. Exit Program Mode	#	○	○	☀

Example:

Set Alarm on Wrong Codes. Leave all other functions unchanged.

Master Code= 1 2 3 4

		Indicator LEDs		
Enter the following keystrokes:		○	○	☀
1. Enter Program Mode	* 1 2 3 4 *	☀	○	○
2. Select Security Menu	6 #	☀	☀	○
3. Skip (Code+1)	#	☀	☀	☀
4. Skip (*+#)	#	○	☀	☀
5. Set (Wrong Codes)	1 #	○	○	☀
6. Skip Anti-default	#	○	○	○
7. Set Tone Mute	#	☀	○	○
8. Exit Program Mode	#	○	○	☀

13. Backing up the unit >>>

Backs up all the user access codes as well as system settings to the optional CP108 Backup Memory Module. This allows the system to be easily restored in the unlikely event of system failure.

Procedure for backing up the unit:

Remove power. Plug the CP108 into the socket provided. Reapply power. All three LEDs will now be on. Press **1** on the keypad.

The green LED will begin to flash, indicating that the memory is being backed up. When the backup is complete, a beep will be heard, and the yellow and green LEDs will turn off. Remove the Backup Memory Module and keep it in a safe place.



- Backing up to a Backup Memory Module will overwrite any information that was previously contained in that Backup Memory Module

14. Restoring the unit >>>

Restores all the user access codes as well as system settings from the optional CP108 Backup Memory Module.

Procedure for restoring the unit:

Remove power. Plug the CP108 into the socket provided. Reapply power. All three LEDs will now be on. Press **3** on the keypad.

The yellow LED will begin to flash, indicating that the memory is being restored. When the restore is complete, a beep will be heard, and the yellow and green LEDs will turn off. Remove the Memory Module, and keep it in a safe place.



- Restoring from a Backup Memory Module will overwrite any information that was previously contained in the **SMARTGUARD** unit

15. Defaulting the unit >>>

Both the Master Code and the system parameters (timers, alarm functions, etc.) can be reset to Factory Defaults.

This is useful when the Master Code has been forgotten or the system parameters are in an unknown state.

Defaulting the Master Code:

Remove power. Reapply power while holding the **1** key down for two seconds. A beep will then follow, indicating that the Master Code has been reset to **1 2 3 4**.

Defaulting the System Parameters:

Remove power. Reapply power while holding the **2** and **3** keys down together for two seconds. A beep will then follow, indicating that the System Parameters have been reset to the following Factory Defaults:

Wrong Codes:	three codes
Wrong Codes Reset:	60 seconds
Wipeout Timer:	5 seconds
Security Parameters:	Anti-default ON, all others OFF

Defaulting is not possible if the anti-default option has been set (see Section 12).

In this case, if the Master Code has been lost, the system must be restored from a backup to reset the Master Code

to **1 2 3 4**



16. Typical mounting instructions: >>>

1. Remove retaining screw cover and screws.
2. Insert screwdriver blade into groove provided between the cover and back panel. Lever screwdriver forward to separate the cover from the back panel.
3. Fix the self-adhesive rubber pads into the recesses provided on the rear panel.
4. Attach the rear pane to the mounting surface or gooseneck with the mounting screws supplied.



Be sure to seal all the mountings with silicone sealant.



Use only the mounting holes shown. If the other mounting holes are used, the mounting screws will interfere with the batteries.

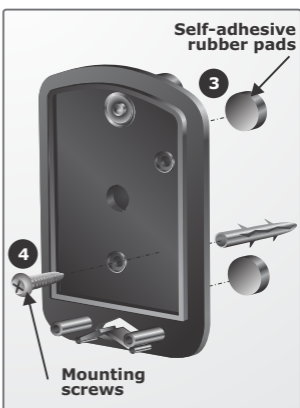
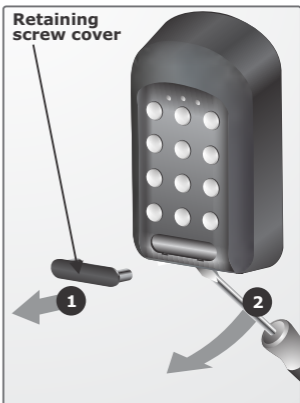

External wiring cable route

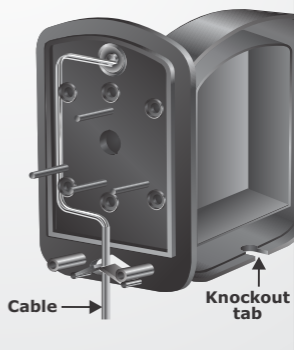

Cable routing

1. In the case of the wiring being mounted externally, knock out the tab in the base of the cover to allow the cable to pass through.
2. If the keypad is to be mounted on a gooseneck, or if the cable must pass through the centre of the back panel, knock out the tab as shown
3. In both the above cases, ensure the cable entry points are sealed with silicon sealant.

Internal wiring cable route

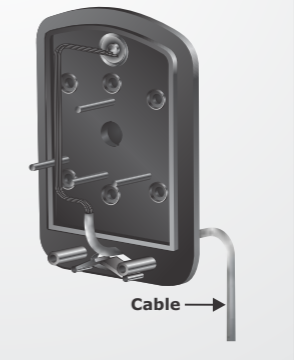

Gooseneck cable route

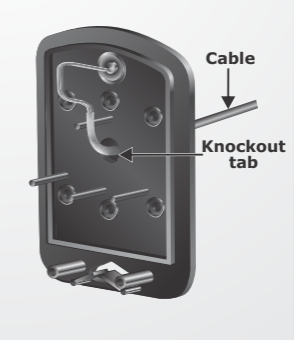

17. Fitting the anti-tamper switch



- If the onboard terminals are used to connect the anti-tamper switch, the switch's normally-closed (N/C) and common connections MUST be used. Normally-closed (N/C) will be connected to In1 and COM to Neg (-)
- If the anti-tamper switch is to be connected to a third-party alarm system, either normally-closed or normally-open can be used, along with a common connection

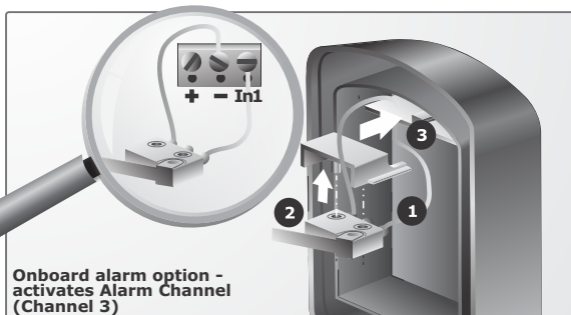

OR

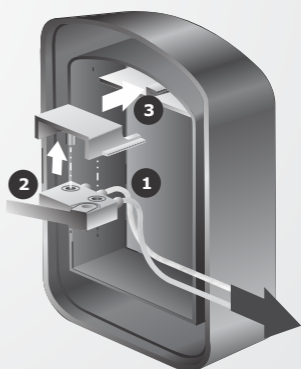

18. Typical connection diagram



If your supply voltage to the SMARTGUARD exceeds 24V AC or 30V DC, fit the supplied 150R resistor in series with the supply wire as shown.

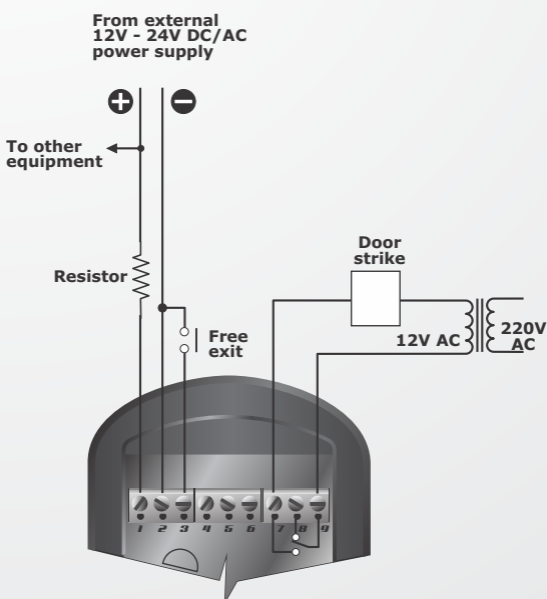

Do not use this product with supply voltages greater than 30v ac or 40v dc.

19. Glossary of terms >>>

Access code

The code number the user will enter to gain access. It can range in length from one to ten digits.

Address/ User address

The location where the user's code is stored in the keypad memory. It can be any number between 1 and 999. It should be recorded, allowing the user code to be removed from the memory later if necessary.

Master Code

The code number required for programming the keypad. It is stored in user address 0.



- **The default Master Code of a new unit 1 2 3 4**
- **For security reasons, the installer should change this code at the time of installation.**
Refer to Section 7 for instructions on how to change the Master Code.

Enter key

In order to gain access, the user code must be followed by a #.

20. Important installation information >>>

Complete the installation information below for future reference.



Keep this manual in a safe place.

Master Code

Channel 1 activates

Channel 2 activates

Channel 3 activates

Channel 4 activates

Channel 5 activates

Channel 6 activates

Channel 7 activates

Channel 8 activates

Channel 9 activates

Channel 10 activates

Channel 11 activates

Channel 12 activates

Channel 13 activates

Channel 14 activates

Channel 15 activates

Installers information:

Name:

Mobile number:

Email address:

Physical address:

For your convenience you will find an Address Register included in your **SMARTGUARD** packaging. Use this Address Register to record which addresses have been assigned, their access code and which channel will be activated by that address.



Keep the address register in a safe place!

The supplied Address Register will record the first 500 addresses, from 0 to 499. Should you require a second Address Register to record the next 500 address, i.e. address 500 to 999, please contact your nearest CENTURION SYSTEMS branch or distributor.

Notes >>>





CENTURION

Sharecall 0860-CENTURION (0860 236 887)
Head Office: +27 11 699 2400

Sharecall Technical Support 0861 003 123 or
+27 11 699 2481
from 07h00 to 18h00 (GMT+2)

(Sharecall numbers applicable when dialed from within South Africa only)



0.07.A.0158_22072013

www.centsys.com